

I
Q
L
I
N
E
A
R
L
E
D
L
A
M
P

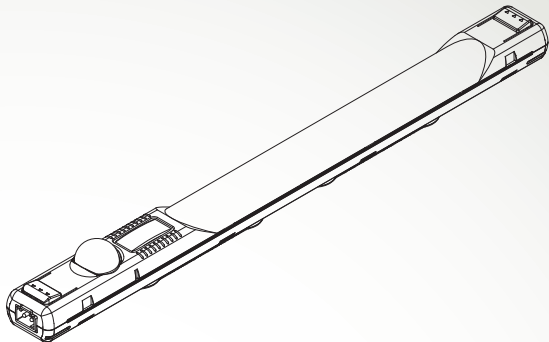

PLAFONIERA LINEARE A LED

LINEAR LED LAMP



Crea il tuo codice IQ
Create your IQ code

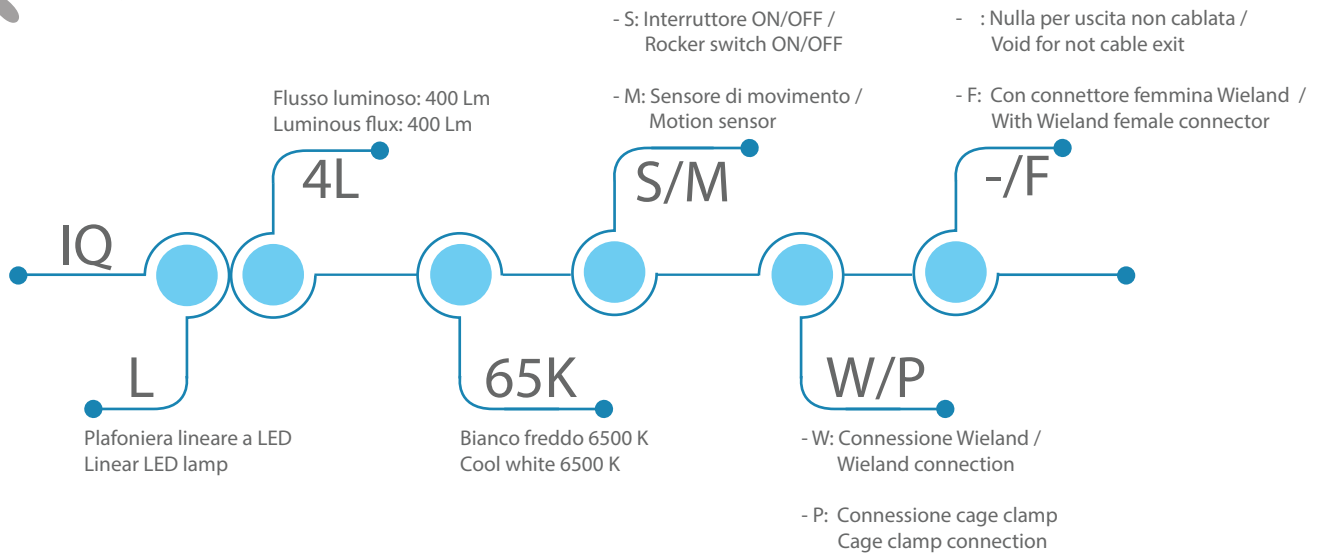

example: IQL4L65KMW



IQ: Caratteristiche generali

IQ: Main features

- 01** USO UNIVERSALE
ampio range di tensione 24V-265V AC/DC /
UNIVERSAL USE
wide voltage range 24V-265V AC/DC
- 02** SENSORE DI MOVIMENTO
sensore con impostazione di 5 minuti /
MOTION SENSOR
movement sensor with 5 minute setting
- 03** INTERRUETTORE on/off /
ROCKER SWITCH on/off
- 04** OPZIONI DI CONNESSIONE
connettore Wieland o connessione cage clamp /
CONNECTION OPTIONS
Wieland plug or cage clamp connection
- 05** RILASCIO A PRESSIONE
applicabile ad entrambi i tipi di connessione /
PUSH TO RELEASE
applicable to every connection type
- 06** MONTAGGIO
magneti integrati o clip di plastica (incluse) /
MOUNTING
Integrated magnets or plastic clips (provided)
- 07** COLLEGAMENTO IN SERIE
max 16 lampade AC / max 8 lampade DC /
DAISY CHAIN
max 16 lamps AC / max 8 lamps DC



Alte prestazioni / High performance

- Emissione luminosa **400Lm** / Light output 400Lm
- Grado di protezione **IP20** / Protection degree IP20
- Funzionamento da **-30°C a +70°C** / Operating range from -30°C to +70°C
- Ciclo di vita: **40 000 ore** / Life time : 40 000 hours
- Energia consumata: **4W** / Power consumption: 4W
- Ampio range di tensione **24V-265V AC/DC** / Wide voltage range 24V-265V AC/DC
- Lampada tipo **LED**, angolo di **120°** / LED lamp type, 120° angle
- Colore della luce: **Bianco freddo**, Temperatura: **6,500K** / Light color: Cool white, Temperature: 6,500K

Approvazioni / Approvals



Dimensioni / Dimensions

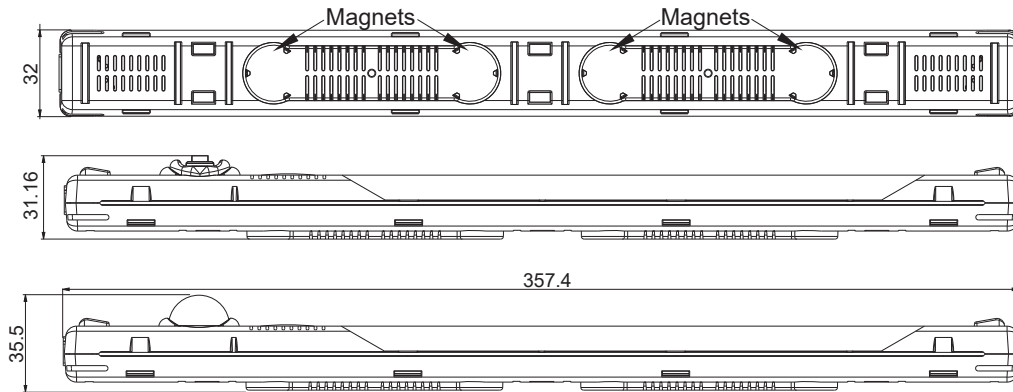

Mounting Accessories

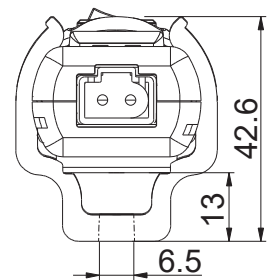

Screw mount clip M6

Montaggio / Mounting

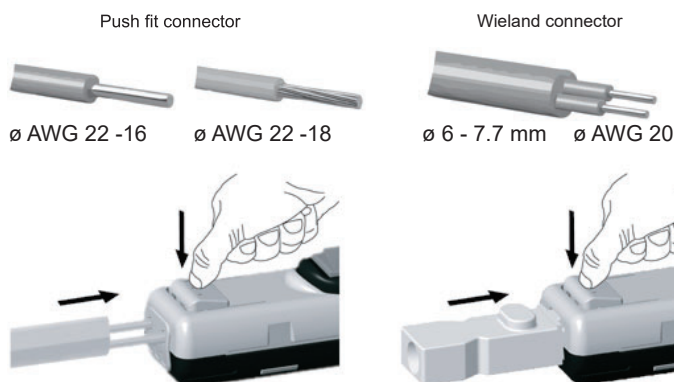

Curva di distribuzione della luce / Light distribution curve

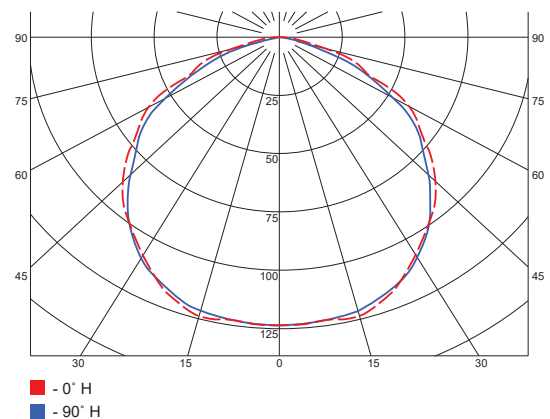

ACCESSORI INTERNO QUADRO / CONTROL CABINET DEVICES

GR01 - Dispositivo lampeggiante completo - GR02 + AP1T10Z11 + AP1R001Z11 / Complete flashing device - GR02 + AP1T10Z11 + AP1R001Z11

GR02 - Dispositivo lampeggiante / Flashing device

GR03 - Dispositivo con comando - GR02 + AP1T10Z11 / Flashing device with command - GR02 + AP1T10Z11

GRFX1 - Piastra di fissaggio standard per dispositivo lampeggiante / Standard bracket for flashing device

PPK02 - Piastra di fissaggio su guida DIN per dispositivo lampeggiante / DIN rail mounting bracket for flashing device

AP1T10Z11 - Interruttore di finecorsa - Pistoncino in Nylon - Contatti a scatto (1NO+1NC) / Limit switch - Nylon plain plunger - Snap action (1NO+1NC)

AP1R001Z11 - Interruttore di finecorsa - Riarmo manuale - Contatti a scatto (1NO+1NC) / Limit switch - Manual reset - Snap action (1NO+1NC)

GR 2116 / GR2117 - Supporto per fissaggio interruttori di finecorsa su vari profili / Fixing bracket for limit switches

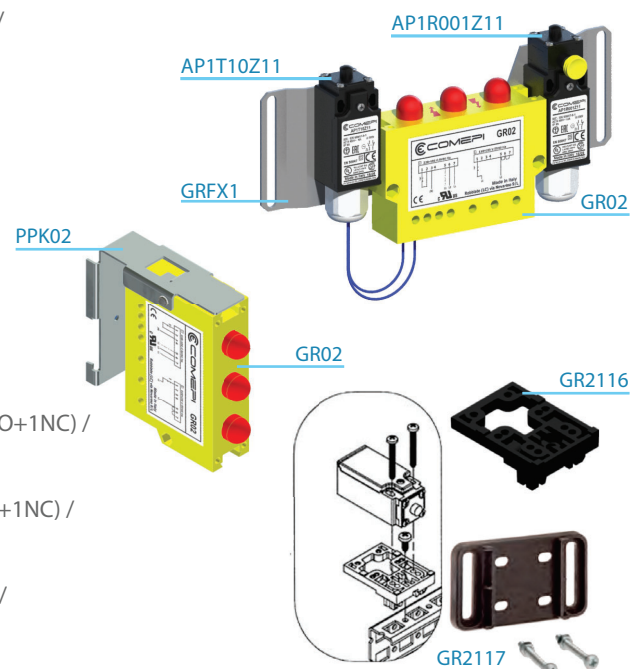



COMEPI SRL
Via Novarino 9/L
23899 Robbiate (LC) ITALY
www.comepi.it
comepi@comepi.it
tel +39 039 9906408
+39 039 9903468
fax +39 039 9906203

